

TEQBALL®
ARE YOU TEQ?

SMART

indoor / outdoor

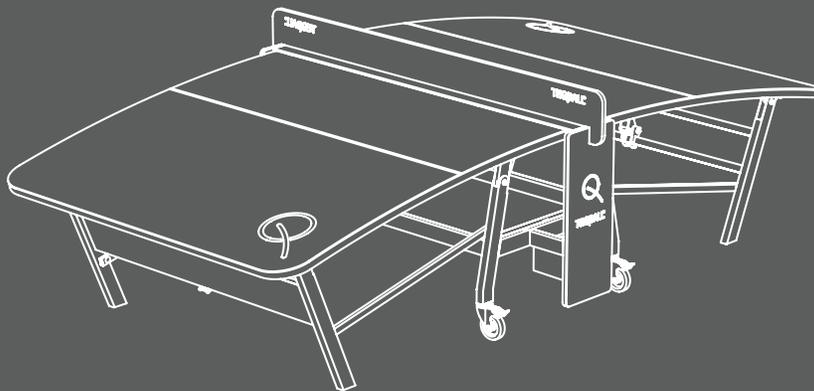

OWNER'S MANUAL

TEQBALL® SMART

Dear Customer,

Thank you for choosing our product. To make the most of your Teqball Smart table every time, we would like to give you some hints and safety instructions in this manual.

The Teqball Smart table is a specially designed piece of sports equipment which has been empirically tested and scientifically developed. Applying the laws of mathematics and physics the ball bounces off of the Teqball Smart table so the players can control and handle the ball in all cases. The net is made of transparent PMMA plate, which means the ball will bounce consistently.

Teqball Smart table is a durable and safe product that can be used indoor and outdoor. The steel undercarriage has corrosion resistant painting and the tabletop consists of an exterior HPL sheet.

The Teqball Smart table is under international patent, trademark and copyright protection.

Find out more about Teqball at

www.teqball.com



SPECIFICATIONS

The size specification of the Teqball Smart table in unfolded position is the following:

- Q Length: 3 000 mm
- Q Width: 1 700 mm (including the net)
- Q Height: 900 mm (top of the net)

The size specification of the Teqball Smart table in folded position is the following:

- Q Length: 880 mm
- Q Width: 1 700 mm (including the net)
- Q Height: 1800 mm

The curvature of the playing surface is determined by the distance of the highest and lowest points of the surface and by the horizontal distance from the lowest (farthest) point of the surface to the height of the net.

The highest point of the playing surface – measured from the ground – is 760 mm, while the lowest point is 565 mm. The horizontal distance between the lowest part of the surface and the net is 1490 mm.

The Teqball Smart table consists of the following materials:

- Q CDP and powder coated S235 structural steel
- Q Exterior HPL laminate
- Q PUR adhesive
- Q Transparent PMMA plate (acrylic glass)

Fasteners and additional components:

- Q Coated stainless steel screws
- Q Stainless steel washers and nuts
- Q Gas springs
- Q Wheels and castors
- Q Additional polymer components

The weight of the Teqball Smart table is 154 kg (excluding the packaging).

CLEANING

Please start the cleaning procedure of the tabletop for unknown stains with basic cleaning. For the last step of the cleaning process you have to perform a final cleaning procedure to prevent streaking. We would like to give you some instructions about cleaning different type of stains. In case of there is any type of stain which is not listed below and you could not clean the tabletop by following the listed cleaning processes please contact us at info@teqball.com

Basic cleaning

- 🔍 Clean the surface with warm water and use a mop (DO NOT use any abrasive sponge).

To clean dust, coffee, tea, fingerprints, fruit juice, grease/fat please use both the following cleaning process and the final cleaning process:

- 🔍 Clean the surface with warm water and use a mop (DO NOT use any abrasive sponge). Add household cleaners without abrasives to the warm water.

Final cleaning

- 🔍 Detergents must be removed with water completely to avoid streaking. Finally clean with warm water and wipe off the surface with an absorbent cloth or paper towel.

MAINTENANCE

Regular maintenance is essential to keep the Teqball Smart table safe and reliable. Lack of maintenance or inadequate maintenance can lead to dangerous situations, accidents and health problems.

- Q Depending on the frequency of use, at least once a month check all screws, bolts etc. to ensure that they function properly. The fasteners are coated with adhesive.
 - ✓ The adhesive is inactive until the coated fastener is used. During assembly the adhesive is activated. The adhesive can prevent the self loosening of fasteners, but the effect of the adhesive is decreasing with every assembly.
- Q Damaged or worn components may endanger your safety or shorten the lifespan of the Teqball Smart table. Stop using the Teqball Smart table immediately and contact us at info@teqball.com.

WARNINGS

To safely enjoy playing TeqSports, please read and understand all enclosed instructions and information before using this product. Use the Teqball Smart table at your own risk. Each person who uses the Teqball Smart table must be informed about the following safety instructions and about the proper use of the Teqball Smart table. Teqball Smart table is a specially designed piece of sports equipment and it is not suitable for any other purposes. Never leave children unattended or uncontrolled in the facility of the Teqball Smart table. Non-observance may cause damages or even accidents which the company is not responsible for. Adult supervision applies to setting up and storing as well as playing on the Teqball Smart table.

- ❏ Do not use it in extreme weather conditions (e.g. storm, lightning).
- ❏ Do not touch the Teqball Smart table in hot weather conditions, as it may heat up and cause burn.
- ❏ Avoid any damage of the playing surface and the supporting framework, otherwise the lifetime of the Teqball Smart table shortens quickly.

The Teqball Smart table must be set up properly and must only be moved in folded position. This is not only for a better gameplay experience but for your safety as well. Please follow these instructions:

- ❏ Set up only on level floor surfaces. If the surface is not even, the connecting parts may not fit together properly.
- ❏ If one or more legs do not rest on the ground set the adjustable feet or safely wedge the legs.
- ❏ Moving or storing the Teqball Smart table on a sloping surface may cause it to tip over, damage, or more seriously, lead to injury. Take the necessary precautions.
- ❏ Wind may cause the Teqball Smart table to tip over, damage, or more seriously, cause personal injury. Take the necessary precautions.

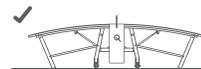
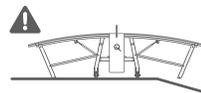

Teqball Smart table is a massive product and improper use can cause injuries. Please be aware of the following instructions:

- ❏ It is strictly forbidden to sit, jump, or stand on the Teqball Smart table or any part of it either it is folded or unfolded.
- ❏ Do not hit or kick the Teqball Smart table, specifically the edges, as it can cause injuries.
- ❏ Do not stay underneath or next to the Teqball Smart table and be careful of trapping fingers, while the tabletop is being lowered.
- ❏ Do not lean or put your weight on the Teqball Smart table because of the risk of collapse.
- ❏ Damaged or worn components may endanger your safety. In this case, stop using the Teqball Smart table immediately.
- ❏ Do not replace defective parts by yourself, and do not alter the construction (removal of original parts, addition of other components etc.) because the Teqball Smart table may become unstable and collapse, causing damages or injuries!
- ❏ The failure of the safety lock may cause damages or injuries. In this case, let the Teqball Smart table in game position and stop using it immediately.
- ❏ Do not leave children unattended around the Teqball Smart table.



DO NOT STAY UNDERNEATH/NEXT TO THE TABLE



DO NOT STAND, OR SIT ON THE TABLE



**DO NOT LEAN OR PUT
YOUR WEIGHT ON THE TABLE**



**DO NOT LEAVE CHILDREN
UNATTENDED AROUND THE TABLE**

HANDLING

The Teqball Smart table must be set up properly. This is not only for the better gameplay experience but for your safety as well. Please follow these instructions:

Lowering the tabletops

1. Lock the wheels. It prevents the unexpected movement of the Teqball Smart table.
2. Unlock the safety lock located on the back of the tabletop.
3. For singles games, lower the tabletop on one side to the game position. Make sure to control the lowering and do not let the tabletop fall down or lift suddenly, as this might cause injury or damage your Teqball Smart table. If you do not feel confident about lowering the tabletop, ask for help.
4. For doubles games, repeat the 2nd and 3rd steps on the other side.

1.



LOCK THE WHEELS

2.

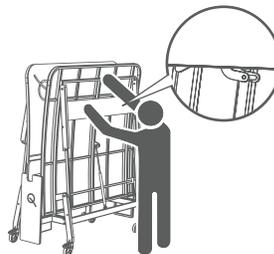

UNLOCK THE SAFETY LOCK

3.

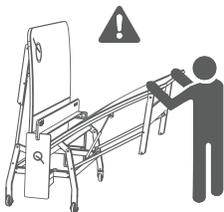

GENTLY LOWER THE TABLETOP

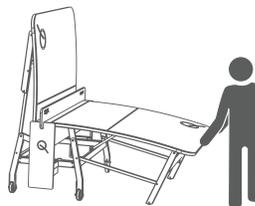

PUT IT GENTLY TO THE GROUND

4.

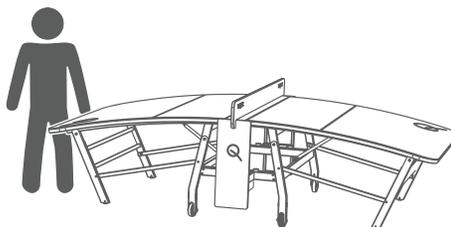

Lifting the tabletops

1. Make sure that the wheels are locked. If they are not locked, lock both.
2. Lift the tabletop to vertical position. Make sure to control the lifting, and do not let the tabletop fall down or lift suddenly, as this might cause injury or damage your Teqball Smart table. If you do not feel confident about lifting the tabletop, ask for help.
3. Check that the safety lock is working properly. To check, try to move the tabletop carefully without unlocking the safety lock. Do not leave the Teqball Smart table until the safety locks are locked in place.
4. Before moving the Teqball Smart table repeat the 2nd and 3rd steps on both side and unlock the wheels. Do not leave the Teqball Smart table unattended with unlocked wheels.

1.

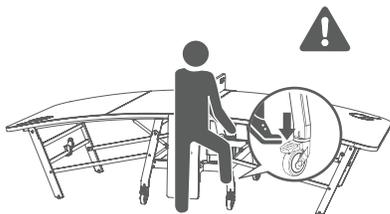

LOCK THE WHEELS

2.

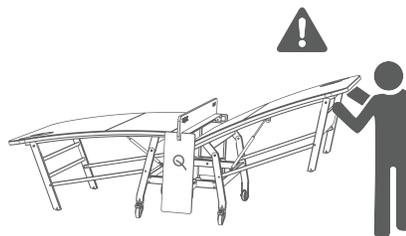

LIFT THE TABLETOP

3.



CHECK THE SAFETY LOCK

4.

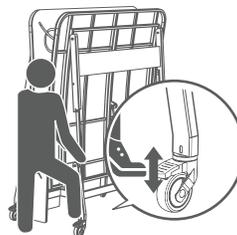

UNLOCK THE WHEELS TO MOVE
THEN LOCK AGAIN

LIMITED 2 YEARS WARRANTY

Teqball International Limited (hereinafter: Company) warrants to the original retail purchaser (hereinafter: Purchaser) that this product will be free from defects in material and workmanship for a period of two (2) years from the date of purchase. Should this product become defective due to material or workmanship within the warranty period, contact our Customer Service Department for repair or replacement at our option via

www.teqball.com/warranty or at info@teqball.com

This warranty is not transferable and does not cover normal tear and wear or damage caused by improper handling, installation or use of this product. This warranty is void if the product is

- Q In any way abused, damaged, or modified from its original state, or if used for other than residential use.
- Q Damaged through improper usage, negligence, misuse, transportation damage, acts of nature or accident (including failure to follow the instructions supplied with the product).
- Q Used in commercial applications or rentals.
- Q Modified or repaired by anyone not authorized by the Company.

This warranty gives the Purchaser specific legal rights, and the Purchaser may have other rights which vary from state to state.

Warranty period: 2 years warranty on tabletop (which includes: 2 pieces of tabletops), 2 years warranty on net (which includes 1 piece of transparent PMMA plate), 2 years warranty on undercarriage (which includes: 1 piece of left and right side console, 2 pieces of swivel wheels, 2 pieces of fixed wheels, 2 pieces of side wall elements I., 2 pieces of side wall elements II. 1 piece of mid console, 1 piece of net fixing element I., 1 piece of net fixing element II., 2 pieces of welded underframes, 2 pieces of welded top steelframes, 4 pieces of leg-connectors, 2 pieces of external legs, 2 pieces of storage boxes, 2 pieces of gas springs, 2 pieces of safety lock elements I., 4 pieces of safety lock elements II.).

WHAT THE COMPANY WILL PAY FOR

If during the warranty period, any part or component of the product is found by the Company to be defective, the Company will, either, repair the product, replace the product with a new product (either the same or an equivalent or an upgraded model), replace the defective part(s) or make the original retailer of the product to exchange the product with a new product (either the same or an equivalent or an upgraded model) or refund the original purchase price of the product, without charge for labour or parts.

The Company's obligation to repair, replace or exchange the product or part(s), however, shall be limited to the amount of the original purchase price of the product.

The warranty is limited to defective parts acknowledged as faulty by the Company. The warranty does not apply to damage caused by: assembly not conforming to these instructions, not complying with the instructions for use and safety, normal wear of parts, lack of maintenance, use of aggressive products for maintenance, wind causing the table to fall in the storage position and, more generally, a cause detrimental to the quality of the table (impact, falls, etc.), damage to paintwork caused by, climatic, thermal, chemical or industrial pollution.

The following are not covered under the warranty: Costs of carriage of faulty parts, visit by a technician, labor, and indemnities in cash or in kind for immobilization of the table during the warranty period. Any claim must indicate the type of table, the serial number that is to be found on the underside of the tabletop and the part(s) in question, and it must be accompanied by a proof of purchase showing the original date of purchase.

SPECIFIC WARRANTY CONDITIONS

Before using the Teqball Smart table in environments with constant extreme weather conditions (extreme cold weather, extreme hot weather, corrosive environment near the sea, etc.) please contact us at info@teqball.com. In this case a specific proposal is given in order to safely enjoy the Teqball Smart table.

Paint warranty

The Teqball Smart table is provided with a warranty for a period of 2 years from the date of purchase against any manufacturing defects with the paintwork.

The only preconditions are:

- 🔍 The defect must be reported as soon as it is discovered at info@teqball.com. This must of course be within the warranty period.
- 🔍 The defect must not be due to external influences such as damage, climatic, thermal, chemical or industrial pollution, insufficient care or maintenance. The case of the defect will be determined by the company at the time of inspection.

Frame protection warranty

Teqball Smart table is provided with a warranty for a period of 2 years from the date of purchasing against through corrosion.

The only preconditions are:

- 🔍 The defect must be reported as soon as it is discovered at info@teqball.com. This must of course be within the warranty period.
- 🔍 The perforation must not have been caused originally by damage, neglect, insufficient care or maintenance or by external corrosion (rusting).
- 🔍 The company must be advised about any rusting as soon as it is found at info@teqball.com.

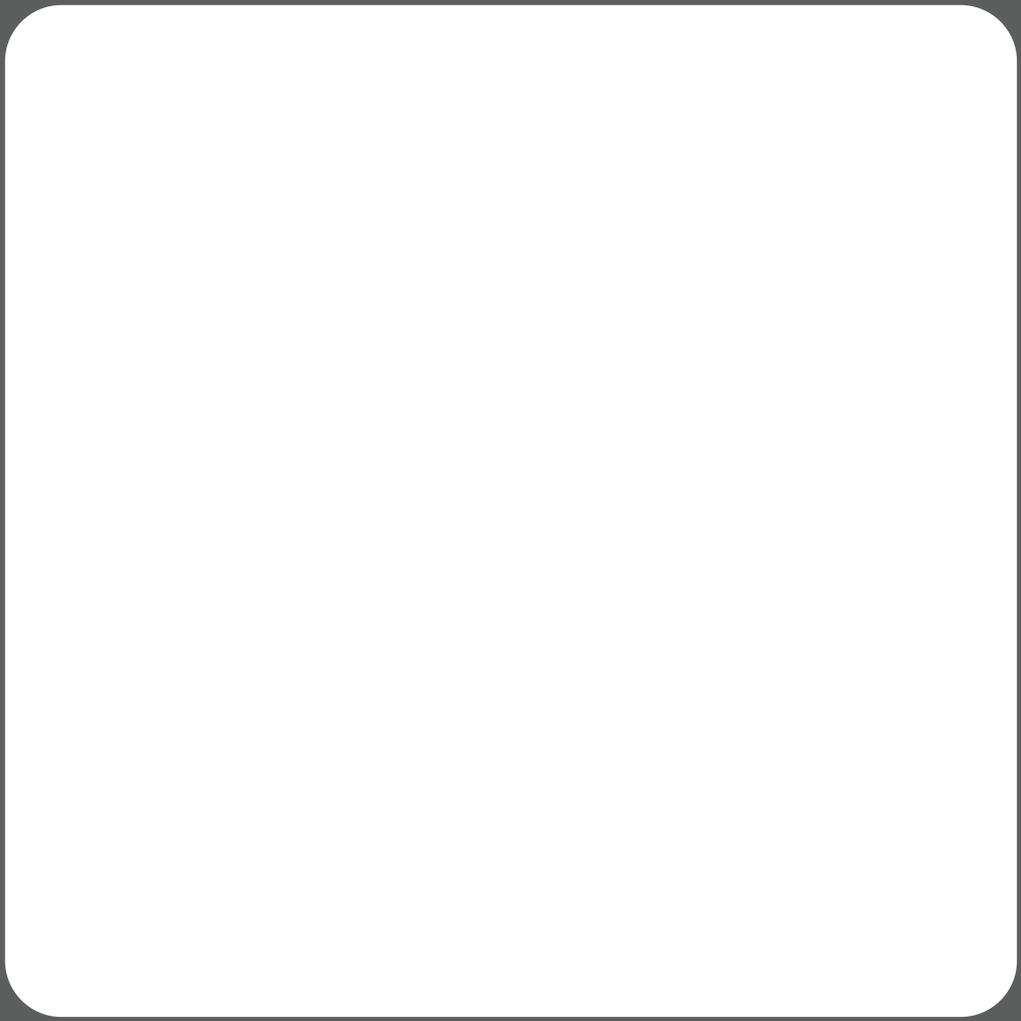

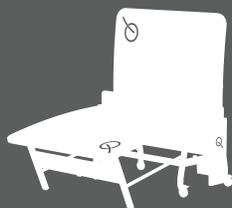

Further information

www.teqball.com

info@teqball.com